



Installation And Operating Manual

TT35WE

F TABLE TOP FREEZER



**Please read these instructions carefully before attempting to install or use this appliance.
It is advisable to keep these instructions in a safe place for future reference.**

Introduction

Thank you for choosing this ICEKING appliance. It has been designed to give years of trouble-free use provided it is installed and maintained correctly.

Please read these instructions carefully before installing or using your appliance. It is advisable to keep your purchase and installation receipts with these instructions in a safe place for future reference. Included is some important safety information in addition to guidelines and recommendations that will enable you to take full advantage of all the functions available.

This quality appliance has been tested and certified to meet all applicable UK electrical and safety standards.

This appliance must be installed and connected in accordance with current regulations by a qualified electrician.

After unpacking the appliance ensure that there is no visible damage. If the appliance has been damaged during transit, do not use it, contact your retailer immediately.

Your 2 year Manufacturer's guarantee

THIS DOES NOT AFFECT YOUR STATUTORY RIGHTS.

Your new **Iceking** appliance carries a free guarantee which protects you against the cost of repairs during the first 24 months from date of purchase provided that: Any claim is accompanied by evidence of the model reference, model serial number and proof of purchase, such as a Sales Receipt, showing that the appliance was purchased within the 24 months prior to the date of claim.

What is not covered under the Guarantee :

Any appliance not correctly installed and operated in accordance with the manufacturer's instructions.

Any appliance that is used for anything other than domestic purposes.

Any defect caused by accident, misuse, unauthorized modification or inexperienced repair.

Cost of Call-out where a fault cannot be found with the appliance.

Cost of Call-out for work covering routine maintenance, such as, but not exclusively, cleaning of filters or defrosting.

Cost of Call-out for work required to correct the alignment of doors following door reversal procedures carried out by you.

Use of the appliance by anyone other than the Householder.

Use in any commercial environment.

Consumable items, such as, but not exclusively, fuses in plugs, bulbs and breakable items which require routine replacement.

Repair costs incurred that have not been authorised by Repairtech and/or carried out by a non-approved Repairtech engineer.

YOUR GUARANTEE IS VALID ONLY IN THE UK & SOUTHERN IRELAND.

To Register your Appliance simply complete the card in your appliance pack and return it with a stamp affixed or Alternatively you can Register online at www.repairtechuk.com

SERVICE HELP-LINE

Should your appliance develop a fault, please call the
Repairtech Service Helpline on:

01527-888133

Please remember to have all your product details available, including the model number, serial number, date of purchase and your retailer's details before registering a fault. Your service call cannot progress without this information.

Safety information



In the interest of your safety and to ensure the correct use, before installing and first using the appliance, read this user manual carefully, including its hints and warnings. To avoid unnecessary mistakes and accidents, it is important to ensure that all people using the appliance are thoroughly familiar with its operation and safety features. Save these instructions and make sure that they remain with the appliance if it is moved or sold, so that everyone using it through its life will be properly informed on appliance use and safety.

For the safety of life and property keep the precautions of these user's instructions as the manufacturer is not responsible for damages caused by omission.

Children and vulnerable people safety

- This appliance can be used by children aged from 8 years and above and persons with reduced physical, sensory or mental capabilities or lack of experience and knowledge if they have been given supervision or instruction concerning use of the appliance in a safe way and understand the hazards involved.
- Children aged from 3 to 8 years are allowed to load and unload this appliance.
- Children should be supervised to ensure that they do not play with the appliance.
- Cleaning and user maintenance shall not be made by children unless they are aged from 8 years and above and supervised.
- Keep all packaging well away from children. There is risk of suffocation.
- If you are discarding the appliance pull the plug out of the socket, cut the connection cable (as close to the appliance as you can) and remove the door to prevent playing children to suffer electric shock or to close themselves into it.
- If this appliance featuring magnetic door seals is to replace an older appliance having a spring lock (latch) on the door or lid, be sure to make that spring lock unusable before you discard the old appliance. This will prevent it from becoming a death trap for a child.

General safety

-  **WARNING!** Keep ventilation openings, in the appliance enclosure or in the built-in structure, clear of obstruction.
-  **WARNING!** Do not use mechanical devices or other means to accelerate the defrosting process, other than those recommended by the manufacturer.
-  **WARNING!** Do not damage the refrigerant circuit.

Safety information

- ⚠ WARNING!** Do not use other electrical appliances (such as ice cream makers) inside of refrigerating appliances, unless they are approved for this purpose by the manufacture.
- ⚠ WARNING!** Do not touch the light bulb if it has been on for a long period of time because it could be very hot.¹⁾
- ⚠ WARNING!** When positioning the appliance, ensure the supply cord is not trapped or damaged.
- ⚠ WARNING!** Do not locate multiple portable socket-outlets or portable power suppliers at the rear of the appliance.
- Do not store explosive substances such as aerosol cans with a flammable propellant in this appliance.
 - The refrigerant isobutane (R-600a) is contained within the refrigerant circuit of the appliance, a natural gas with a high level of environmental compatibility, which is nevertheless flammable.
 - During transportation and installation of the appliance, be certain that none of the components of the refrigerant circuit become damaged.
 - avoid open flames and sources of ignition
 - thoroughly ventilate the room in which the appliance is situated
 - It is dangerous to alter the specifications or modify this product in any way. Any damage to the cord may cause a short circuit, fire and/or electric shock.
 - This appliance is intended to be used in household and similar applications such as
 - staff kitchen areas in shops, offices and other working environments;
 - farm houses and by clients in hotels, motels and other residential type environments;
 - bed and breakfast type environments;
 - catering and similar non-retail applications.
- ⚠ WARNING!** Any electrical components(plug, power cord, compressor and etc.) must be replaced by a certified service agent or qualified service personnel.
- ⚠ WARNING!** The light bulb supplied with this appliance is a “special use lamp bulb” usable only with the appliance supplied. This “special use lamp” is not usable for domestic lighting.¹⁾

1) If there is a light in the compartment.

Safety information

- Power cord must not be lengthened.
- Make sure that the power plug is not squashed or damaged by the back of the appliance. A squashed or damaged power plug may overheat and cause a fire.
- Make sure that you can come to the mains plug of the appliance.
- Do not pull the mains cable.
- If the power plug socket is loose, do not insert the power plug. There is a risk of electric shock or fire.
- You must not operate the appliance without the lamp.
- This appliance is heavy. Care should be taken when moving it.
- Do not remove nor touch items from the freezer compartment if you hands are damp/wet, as this could cause skin abrasions or frost/freezer burns.
- Avoid prolonged exposure of the appliance to direct sunlight.

Daily use

- Do not put hot on the plastic parts in the appliance.
- Do not place food products directly against the rear wall.
- Frozen food must not be re-frozen once it has been thawed out.¹⁾
- Store pre-packed frozen food in accordance with the frozen food manufacture's instructions.¹⁾
- Appliance's manufactures storage recommendations should be strictly adhered to. Refer to relevant instructions.
- Do not place carbonated or fizzy drinks in the freezer compartment as it creates pressure on the container, which may cause it to explode, resulting in damage to the appliance.¹⁾
- Ice lollies can cause frost burns if consumed straight from the appliance.¹⁾

To avoid contamination of food, please respect the following instructions

- Opening the door for long periods can cause a significant increase of the temperature in the compartments of the appliance.
- Clean regularly surfaces that can come in contact with food and accessible drainage systems.
- Clean water tanks if they have not been used for 48h; flush the water system connected to a water supply if water has not been drawn for 5 days.
- Store raw meat and fish in suitable containers in the refrigerator, so that it is not in contact with or drip onto other food.
- Two-star frozen-food compartments (if they are presented in the appliance) are suitable for storing pre-frozen food, storing or making ice-cream and making ice cubes.

¹⁾ If there is a freezer compartment.

²⁾ If there is a fresh-food storage compartment.

Safety information

- One-, two- and three -star compartments (if they are presented in the appliance) are not suitable for the freezing of fresh food.
- If the appliance is left empty for long periods, switch off, defrost, clean, dry and leave the door open to prevent mould developing within the appliance.

Care and cleaning

- Before maintenance, switch off the appliance and disconnect the mains plug from the mains socket.
- Do not clean the appliance with metal objects.
- Do not use sharp objects to remove frost from the appliance. Use a plastic scraper.¹⁾
- Regularly examine the drain in the refrigerator for defrosted water. If necessary, clean the drain. If the drain is blocked, water will collect in the bottom of the appliance.²⁾

Installation

Important! For electrical connection carefully follow the instructions given in specific paragraphs.

- Unpack the appliance and check if there are damages on it. Do not connect the appliance if it is damaged. Report possible damages immediately to the place you bought it. In that case retain packing.
- It is advisable to wait at least four hours before connecting the appliance to allow the oil to flow back in the compressor.
- Adequate air circulation should be around the appliance, lacking this leads to overheating. To achieve sufficient ventilation, follow the instructions relevant to installation.
- Wherever possible the spacers of the product should be against a wall to avoid touching or catching warm parts (compressor, condenser) to prevent possible burn.
- The appliance must not be located close to radiators or cookers.
- Make sure that the mains plug is accessible after the installation of the appliance.

Service

- Any electrical work required to do the servicing of the appliance should be carried out by a qualified electrician or competent person.
- This product must be serviced by an authorized Service Center, and only genuine spare parts must be used.

Energy saving

- Don't put hot food in the appliance;
- Don't pack food close together as this prevents air circulating;
- Make sure food don't touch the back of the compartment(s);



1) If there is a freezer compartment.

2) If there is a fresh-food storage compartment.

Safety information

- If electricity goes off, don't open the door(s);
- Don't open the door(s) frequently;
- Don't keep the door(s) open for too long time;
- Don't set the thermostat on exceeding cold temperatures;
- Some accessories, such as drawers, can be removed to get larger storage volume and lower energy consumption.

Environment Protection

 This appliance does not contain gasses which could damage the ozone layer, in either its refrigerant circuit or insulation materials. The appliance shall not be discarded together with the urban refuse and rubbish. The insulation foam contains flammable gases: the appliance shall be disposed according to the appliance regulations to obtain from your local authorities. Avoid damaging the cooling unit, especially the heat exchanger. The materials used on this appliance marked by the symbol  are recyclable.



The symbol on the product or on its packaging indicates that this product may not be treated as household waste. Instead it should be taken to the appropriate collection point for the recycling of electrical and electronic equipment. By ensuring this product is disposed of correctly, you will help prevent potential negative consequences for the environment and human health, which could otherwise be caused by inappropriate waste handling of this product. For more detailed information about recycling of this product, please contact your local council, your household waste disposal service or the shop where you purchased the product.

Packaging materials

The materials with the symbol are recyclable. Dispose the packaging in a suitable collection container to recycle it.

Disposal of the appliance

1. Disconnect the mains plug from the mains socket.
2. Cut off the mains cable and discard it.



 **WARNING!** During using, service and disposal the appliance, please pay attention to symbol as left side, which is located on rear of appliance (rear panel or compressor). It's risk of fire warning symbol. There are flammable materials in refrigerant pipes and compressor. Please be far away fire source during using, service and disposal.

Description of the Appliance



CONTENTS:

Section 1. Installation

Section 2. Safety Advice

Section 3. Operating the Appliance

Section 4. Maintenance

Section 1. Installation

- **IMPORTANT!** This appliance must be left to stand in an upright position for at least 4 hours before being switched on for the first time.
- This appliance has been designed for Domestic Use Only.
- Remove all packaging and securing tape from the appliance.
- Wash the interior of the appliance with luke warm water containing a small amount of bicarbonate soda (5ml to 0.5 litres of water).
- This appliance has been designed and manufactured to operate efficiently within an ambient temperature range of +16° to +32°C.
- **It is not recommended to site this appliance in a cold atmosphere, i.e. garage, cellar or shed where the temperature may fall below 10°C. Doing so may cause the freezer unit to under freeze and lead to condensation issues – see below.**
- **N.B. If you site this appliance in a garage/out-building or any other cold environment, condensation may occur depending on the ambient temperature. This may form on the outer cabinet and “pool” under the appliance. This is quite normal and does not indicate that there is a fault with the appliance. However, condensation droplets may also enter the appliance and damage the insulation.**
- **N.B. Condensation or related problems such as rust are not covered under the manufacturers guarantee!**
- **N.B. If you site this appliance in a very warm room/environment, i.e. conservatory, the motor may run continuously and the required temperature may not be achieved inside the cabinet.**
- Position the appliance in a dry atmosphere and out of direct sunlight.
- Do not position next to a cooker or other sources of heat, i.e. radiator.
- Leave a minimum gap of 2cm between the appliances in order to avoid condensation.
- Please ensure that there is a small ‘air-gap’ between the appliance and the rear and side walls.
- Do not place or store heavy items on the top of this appliance.
- Ensure that the appliance is positioned on a firm flat floor.
- This appliance must be level.
- Ensure that the appliance is upright and wheels/feet are in firm contact with the floor so that the cabinet is stable.
- Connect the plug to an adjacent 13amp socket outlet and ensure that the appliance is not standing on the supply cable.

Section 2. Safety Advice

- Please read this booklet thoroughly before installing and switching on the appliance. The manufacturer accepts no responsibility for incorrect installation and usage.
- If this appliance is to replace an old refrigerator, as a safety measure remove the door/doors before disposal.
- Your old appliances contain insulation gases and refrigerant that must be disposed of correctly. Please ensure that the refrigerant circuit is not damaged before the appliance is taken away for correct disposal in line with current legislation. If there is any doubt contact your Local Authority for instructions.
- This appliance may contain the refrigerant isobutene (R600a). This is a natural gas with a high level of environmental compatibility; however, caution is required as isobutene is a flammable gas. It is essential to ensure that refrigerant tubes are not damaged during transportation and the installation of the appliance. In the event that the refrigerant circuit is damaged, avoid naked flames or sources of ignition and ventilate the room in which the appliance is situated.
- Do not damage the refrigerant circuit.
- This appliance shall not be used by children aged from 8 years and above and persons with reduced physical, sensory or mental capabilities, or lack of experience and knowledge, unless they have been given supervision or instruction on how to use of the appliance in a safe way and understand the hazards involved. Children shall not play with the appliance. Cleaning and user maintenance shall not be made by children without supervision.
- If using an adaptor, this must be used in accordance with the manufacturers instructions and ensure that the electrical circuit is not overloaded as this could cause overheating.
- Do not twist or bend the cables, and keep them away from hot surfaces.
- Do not plug in or unplug this appliance with wet hands.
- Following installation make sure that the power cable is not trapped underneath the appliance.
- If the power supply cord is damaged, it must be replaced by the manufacturer, it's service agent or similarly qualified persons in order to avoid a hazard.

Section 3. Operating the Appliance

3.1. Switching on the Appliance

Allow the appliance to stand for a minimum of 4 hours after installation. Plug in the appliance and switch on at the mains supply. Set the thermostat control to the required setting as detailed in the Temperature Control section (3.2.). Leave the appliance for approximately 4 hours for the correct temperature to be reached.

3.2. Temperature Control

The temperature control dial is located on the rear external wall of the appliance.

Setting "Min": Warmest Temperature
Setting "Normal": Normal Operation (adequate for most situations)
Setting "Max": Coldest Temperature

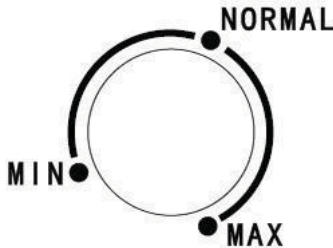

Important!

During high ambient temperatures e.g. on hot summer days, it may be necessary to set the thermostat to the coldest setting (position "Max"). This may cause the compressor to run continuously in order to maintain a low temperature in the cabinet.

3.3. Storing & Freezing Food in the Freezer

This appliance is a four star freezer and is suitable for the long-term storage of frozen food items. It can also be used for freezing and storing fresh food items.

You should always follow the storage guidelines printed on each food producers packaging, however the following information is provided as a general guide for the maximum storage life of frozen items:

Fresh Meat and Poultry – up to 12 months
Cooker Meats – up to 2 months
Fresh Fish – up to 6 months
Fruit and Vegetables – up to 12 months
Bread and Cakes – up to 6 months

3.4. Normal Operating Sounds

You may hear faint gurgling or bubbling sounds when the refrigerant is pumped to the cooling system and through the coils or tubing at the rear of the appliance. When the compressor is in operation you may hear a slight whirring sound or pulsating noise. The thermostat controls the operation of the compressor, and you may hear a slight click as it cycles in and out.

3.5. Energy Saving Advice

Do not install the appliance close to sources of heat, such as a cooker, dishwasher or radiator.

Locate the appliance in a cool well-ventilated room and make sure that the air vents are clear.

Try to avoid keeping the door open for a long time, warm air will enter the cabinet and may cause a build up of ice as well as affecting the energy consumption. Ensure there are no obstructions preventing the door from closing properly.

Ensure that the door seal is clean and there are no tears or splits. Do not put hot food into the freezer – let it cool down first.

3.6. In the Event of a Power Failure

If there is a power failure, keep the door closed. When the power has been restored the appliance will start to operate but it may take some time to achieve the pre-set operating temperature. Check the condition of your stored food items and liquids.

3.7. Food Storage Advice

- Do not place food products directly against the rear wall.
- Frozen food must not be re-frozen once it has been thawed out.
- Store pre-packed frozen food in accordance with the food manufacturer's instructions.
- Food storage recommendations should be strictly adhered to.
- Do not place fizzy drinks in the freezer compartment as it creates pressure on the container, which may cause it to explode, resulting in damage to the appliance.
- Ice-lollies can cause frost burns if consumed straight from the freezer.
- Positioning the different food in different compartments according to below table:

Temperature Setting Recommendation	Type of food
Freezer drawer(s)/ shelf	<ul style="list-style-type: none">- Food for long-term storage- Bottom drawer/ shelf for raw meat, poultry, fish.- Top drawer/ shelf for ice cream, frozen fruit, frozen baked goods.

Section 4. Maintenance

Before any maintenance or cleaning work is carried out, DISCONNECT the appliance from the ELECTRICITY supply.

4.1. Internal Cleaning

Clean the interior and accessories with warm water and bicarbonate of soda (5ml to 0.5 litre of water). Rinse and dry thoroughly. Do not use detergents, abrasive powders, highly perfumed cleaning products, wax polishes or cleaning products containing bleach or alcohol.

4.2. External Cleaning

Wash the outer cabinet with warm soapy water. Do NOT use abrasive products. There may be sharp edges on the underside of the product, so care should be taken when cleaning. Once or twice a year dust the rear of the appliance and the compressor at the back of the appliance, with a brush or vacuum cleaner, as an accumulation of dust will affect the performance of the appliance and cause increased energy consumption.

4.3. Defrosting

If ice build up within the cabinet exceeds 3-5mm, empty the contents and switch off the appliance, leave the door open and allow the ice to melt. **Do not use sharp objects to scrape the ice away.** Clean and dry the interior, close the door and turn on the power to the appliance. When the power has been restored the appliance will start to operate but it may take some time to achieve the pre-set operating temperature.

4.4. When the appliance is not in use

When the appliance is not in use for long periods, remove the contents, disconnect from the electricity supply and clean the appliance, leaving the door ajar until you wish to use the appliance again.

4.5. Reversing the door

To reverse the door opening from right hand hinged to left hand hinged, please proceed as follows:

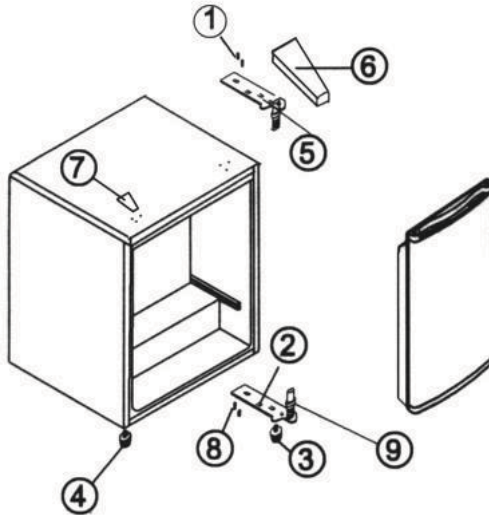

Remove the upper hinge cover (6) screws (1) and hinge (5)

Lift the door away from the lower hinge

Remove the screws (8) and lower hinge assembly (2)

Remove the pin (9) and foot (3) from the hinge

Turn the hinge over and re-fit the pin (9) & foot (3) on the other side Now fit the lower hinge assembly using the pre-drilled holes on the lower left hand side of the cabinet and fit the foot (4) to the r-hand side Remove the plastic caps (7) from the top left hand side and refit them into the holes on the top right hand side

Remove the plastic cap from the top left hand side of the door and refit into the hole on the top right hand side

Position the door onto the lower hinge assembly and refit the upper hinge assembly .

Ensure that the door is correctly aligned and sealed, then tighten all the screws and refit the upper hinge cover

4.6. What to do if something goes wrong

There is no power to the appliance:

- Check there is not a power cut
- Check there is power to the electric socket/appliance
- Check the fuse in the plug (Must be 13 amp)
- Check that the Temperature Control is set to "Min" or above

The compressor runs continuously:

- Is the door closed correctly?
- Have large quantities of food recently been added to the appliance? – if yes, allow the interior temperature to recover
- Has the appliance door been opened frequently? – if yes, allow the interior temperature to recover
- Check that the Temperature Control has not been set to maximum ("Max")

There is excessive frost/ice build up:

- Ensure that the door has been closed correctly
- Ensure that the door seal is clean and sealing correctly
- Check that the Temperature Control has not been set to maximum ("Max")

The appliance is making a noise:

- Refer to Normal Operating Sounds, section 3.4.
- Ensure that the appliance has been installed correctly (see section 1).

YOUR GUARANTEE IS VALID ONLY IN THE UK & SOTHERN IRELAND.

To Register your Appliance simply complete the card in your appliance pack and return it with a stamp affixed or *Alternatively* you can Register online at www.repairtechuk.com

SERVICE HELP-LINE

Should your appliance develop a fault, please call the

Repairtech Service Helpline on:

01527-888133

Please remember to have all your product details available, including the model number, serial number, date of purchase and your retailer's details before registering a fault. Your service call cannot progress without this information.

DOMESTIC APPLIANCE DISTRIBUTORS;
HENRY JOHN HOUSE
NORTHWAY LANE
ASHCHURCH
TEWKESBURY
GLOUCESTERSHIRE
GL20 8J

Insurance

**! Any warranty provided with this product does not cover !
loss of fridge/freezer content.**

Any claim for loss, damage, costs or expenses of an indirect or consequential nature including any economic loss or damage to foodstuffs or any other goods is excluded. We recommend that you inspect your fridge/freezer regularly to check that it is working correctly, losses can result from deterioration following breakdown or accidental failure of the appliance, fuses, plugs or public electricity supply, these can be covered by your standard home insurance or might require extra cover. Check with your insurance provider.

Important Note:

This appliance is marked according to the European directive 2002/96/EC on Waste Electrical and Electronic Equipment (WEEE). By ensuring this product is disposed of correctly, you will help prevent potential negative consequences for the environment and human health, which could otherwise be caused by inappropriate waste handling of this product.

The symbol on the product, or on the documents accompanying the product, the Crossed Out Wheelie Bin, indicates that this appliance may not be treated as household waste. Instead it shall be handed over to the applicable collection point for the recycling of electrical and electronic equipment.

Disposal must be carried out in accordance with local environmental regulations for waste disposal. For more detailed information about treatment, recovery and recycling of this product, please contact your local authority, your household waste disposal service or the retailer where you purchased the product.



We continuously try to improve our products for the benefit of our customers. For this reason we reserve the right to make changes to any product at any time, without notice.

Issue: 05/10-11-2020

